

SCHEDA TECNICA / TECHNICAL DATA

RUBINETTERIE RITMONIO S.R.L. si riserva tutti i diritti connessi con il presente documento e con l'oggetto o la materia ivi rappresentati con divieto di riproduzione, utilizzarlo o renderlo accessibile a terzi in assenza di previa autorizzazione. Disegno CAD non modificabile a mano

RUBINETTERIE RITMONIO S.R.L. will claim all rights related to the present document and with the object or subject represented therein with the prohibition of reproduction, use or disclosure to third parties without previous permission. The Cad plan is not alterable by hand

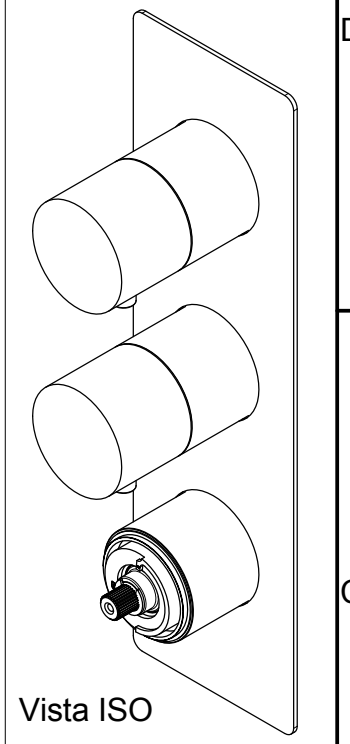
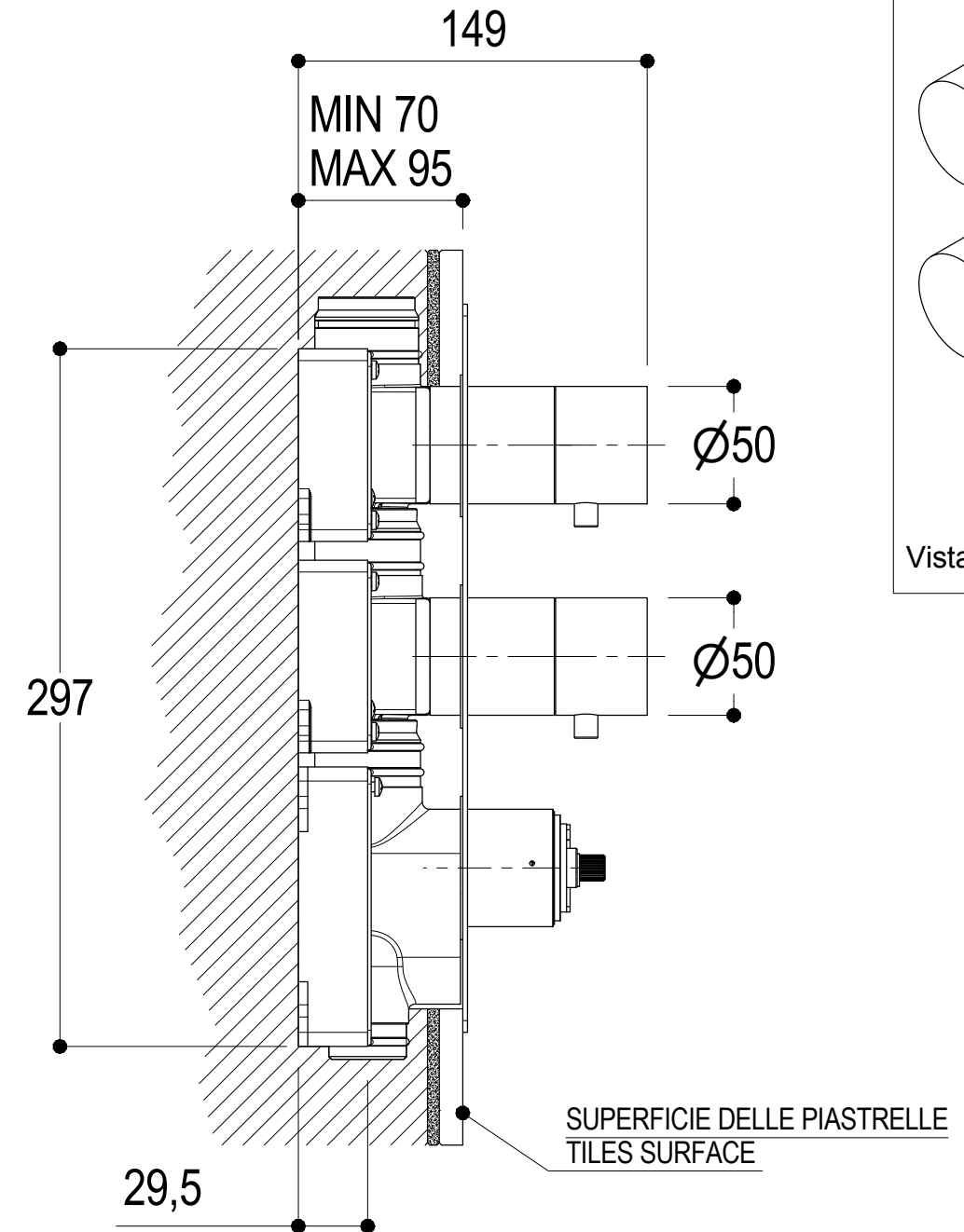
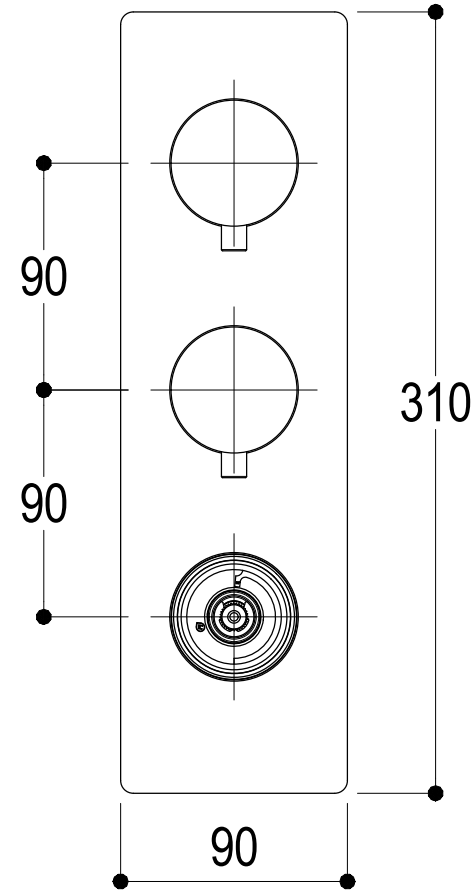
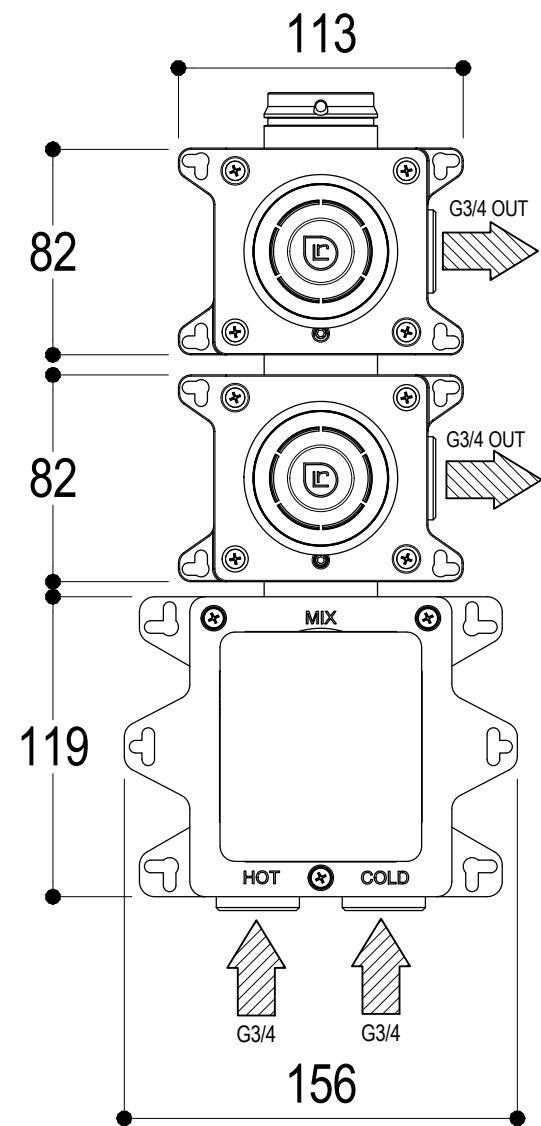

	SERIE DIAMETRO35 IMPRONTE	CODICE PR51HR101	DATA EMISSIONE 30/06/2021
	DENOMINAZIONE Mix termostatico ad incasso con deviazione 2 vie Built-in thermostatic mixer with 2 ways diverter		REVISIONE /

SCHEDA TECNICA / TECHNICAL DATA

RUBINETTERIE RITMONIO S.R.L. si riserva tutti i diritti connessi con il presente documento e con l'oggetto o la materia ivi rappresentati con divieto di riprodurlo, utilizzarlo o renderlo accessibile a terzi in assenza di previa autorizzazione. Disegno CAD non modificabile a mano

RUBINETTERIE RITMONIO S.R.L. will claim all rights related to the present document and with the object or subject represented therein with the prohibition of reproduction, use or disclosure to third parties without previous permission. The Cad plan is not alterable by hand

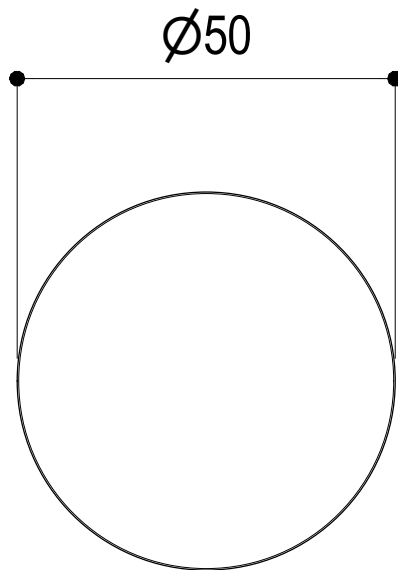
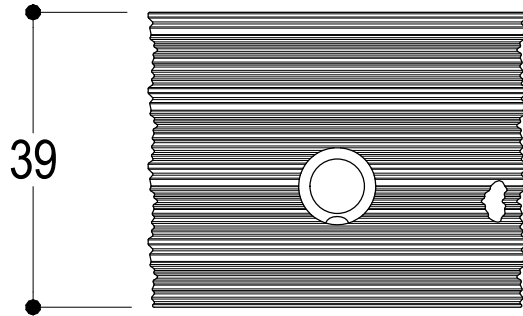

Vista ISO

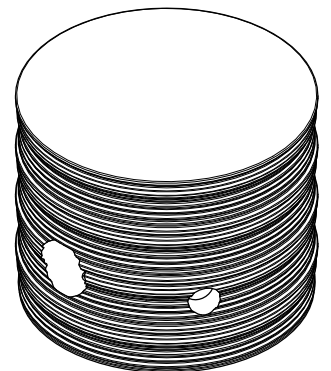

Ritmonio
Living a quality experience.
13019 VARALLO - (VC) - ITALY

SERIE
DIAMETRO35 IMPRONTE

CODICE
PR51MF003

DATA EMISSIONE
13/01/2022

DENOMINAZIONE
COMANDO SENZA LEVA
HANDLE WITHOUT LEVER

REVISIONE /

SCHEDA DI PORTATA / FLOW RATE DATA

RUBINETTERIE RITMONIO S.R.L. si riserva tutti i diritti connessi con il presente documento e con l'oggetto o la materia ivi rappresentati con divieto di riprodurlo, utilizzarlo o renderlo accessibile a terzi in assenza di previa autorizzazione. Disegno CAD non modificabile a mano

RUBINETTERIE RITMONIO S.R.L. will claim all rights related to the present document and with the object or subject represented therein with the prohibition of reproduction, use or disclosure to third parties without previous permission. The Cad plan is not alterable by hand



Living a quality experience.

13019 VARALLO - (VC) - ITALY

I diagrammi riportati di seguito riassumono i valori riscontrati durante le prove di portata dei seguenti articoli. Le prove sono state effettuate con pressioni che variavano da 1 a 5 bar e in posizione di acqua miscelata

The following diagrams sum up the values, taken from flow tests of the following items. Tests were conducted with pressure variations from 1 to 5 bar and with mixed water.

BUILT-IN PARTS

Art. PM0030H - PM0030J - PM0030L - PM0030M

Parte incasso miscelatore termostatico

Built-in thermostatic mixer

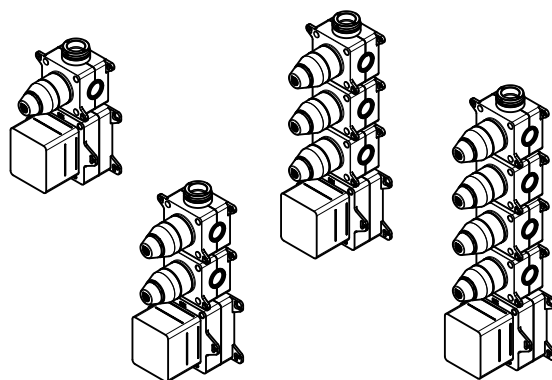

Una Uscita / One Outlet

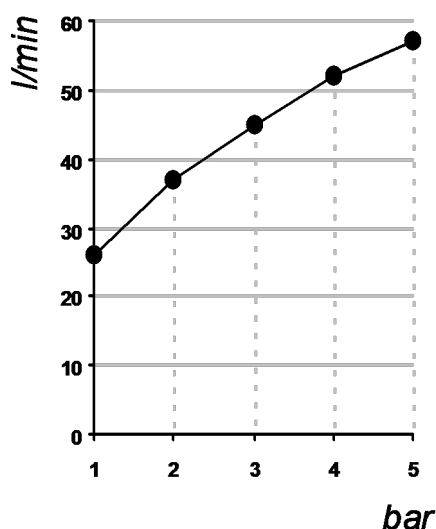

bar	1	2	3	4	5
l/min	26	37	45	52	57

Due-Tre-Quattro Uscite / Two-Three-Four Outlets

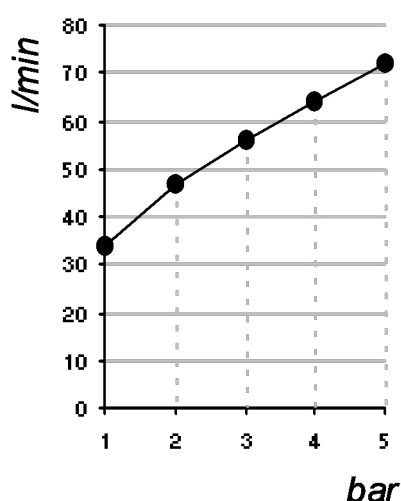

bar	1	2	3	4	5
l/min	34	47	56	64	72

REVISIONE

/

DATA EMISSIONE

29/09/2022