

# SCHEDA TECNICA / TECHNICAL DATA

RUBINETTERIE RITMONIO S.R.L. si riserva tutti i diritti connessi con il presente documento e con l'oggetto o la materia ivi rappresentati con divieto di riproduzione, utilizzarlo o renderlo accessibile a terzi in assenza di previa autorizzazione. Disegno CAD non modificabile a mano

RUBINETTERIE RITMONIO S.R.L. will claim all rights related to the present document and with the object or subject represented therein with the prohibition of reproduction, use or disclosure to third parties without previous permission. The Cad plan is not alterable by hand

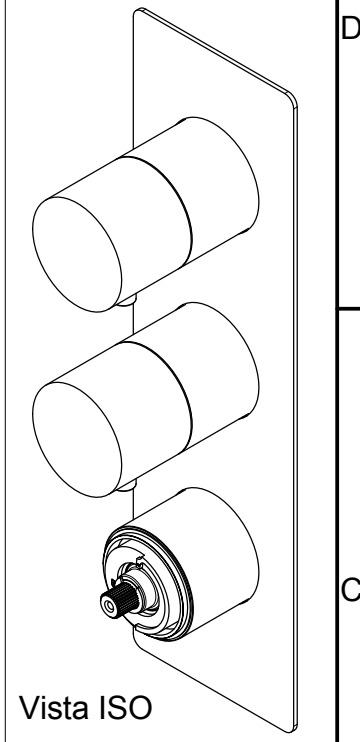
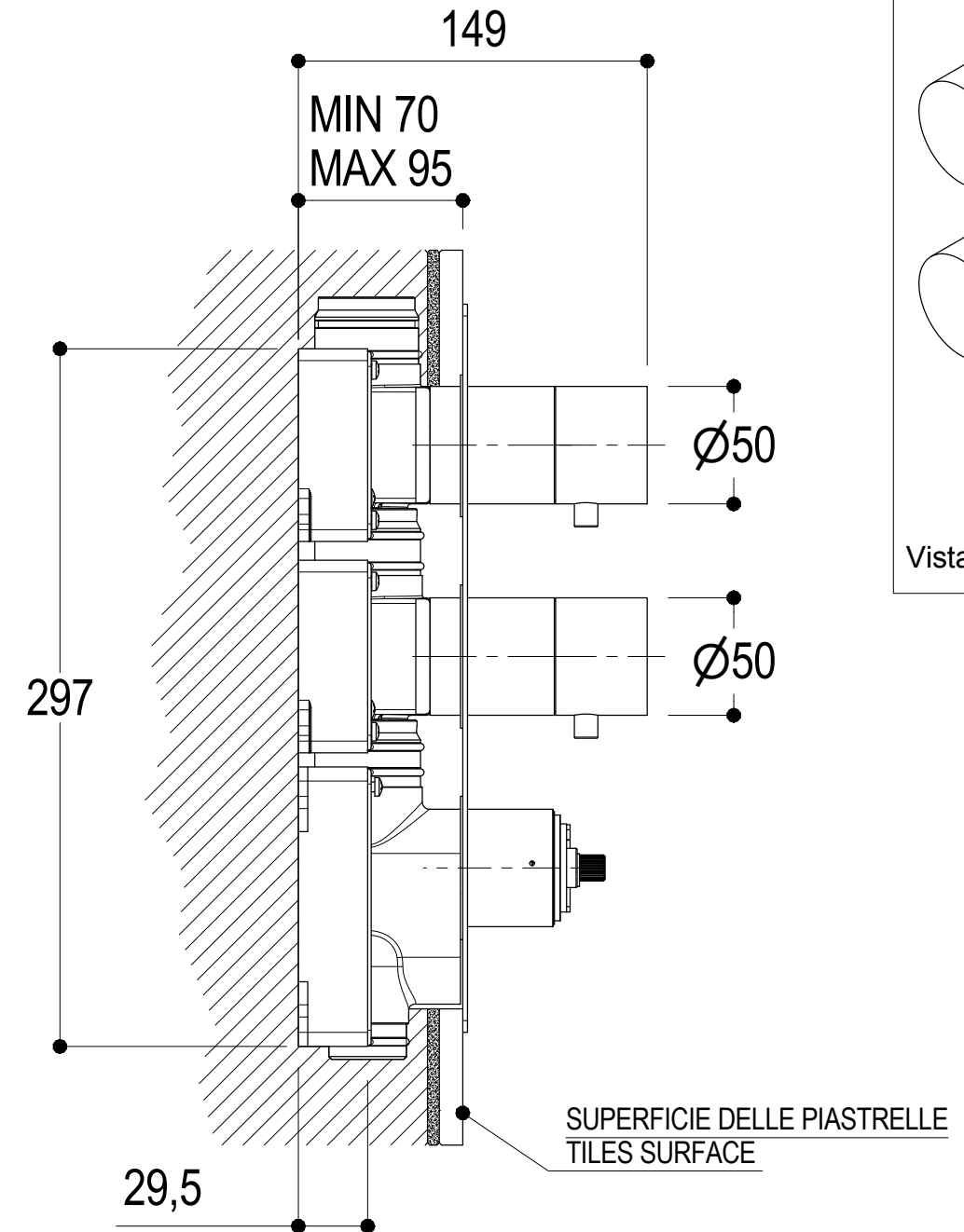
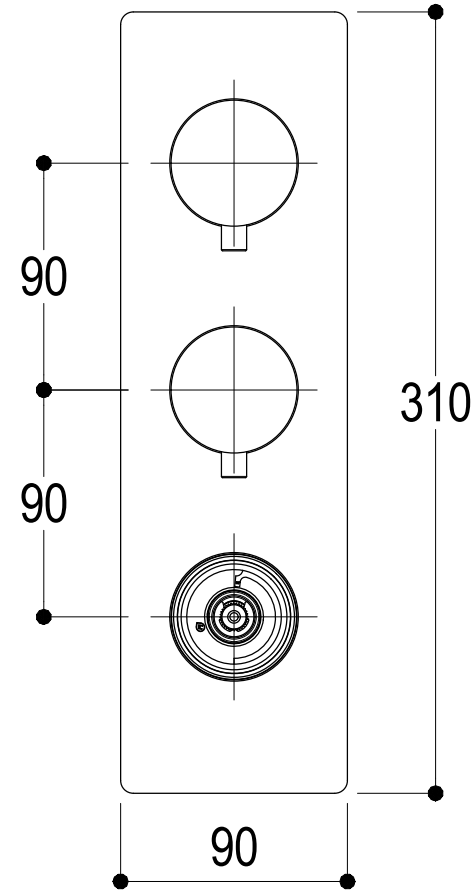
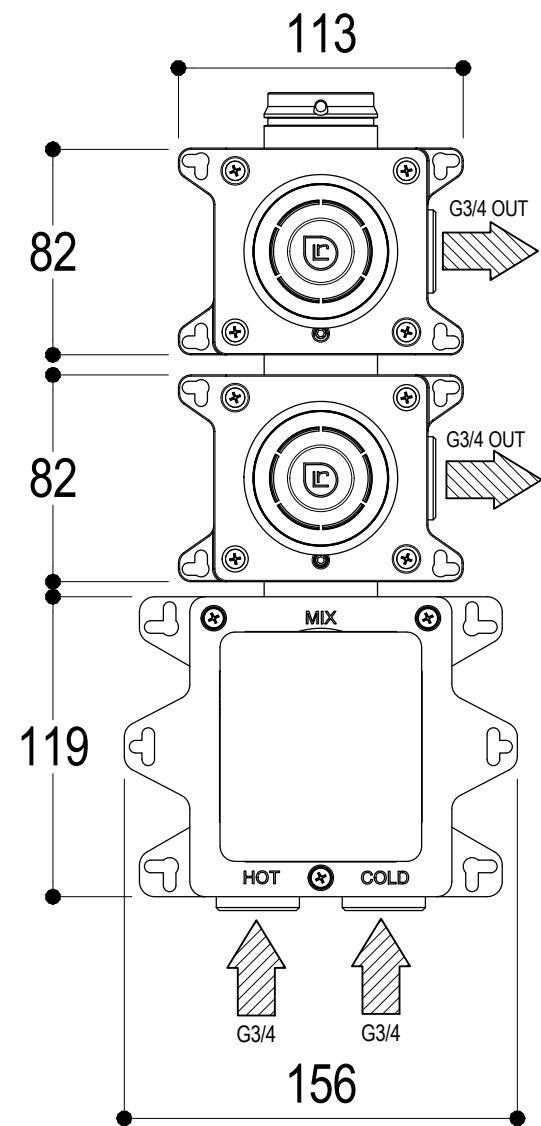

	SERIE DIAMETRO35 IMPRONTE	CODICE PR51HR101	DATA EMISSIONE 30/06/2021
	DENOMINAZIONE Mix termostatico ad incasso con deviazione 2 vie Built-in thermostatic mixer with 2 ways diverter		REVISIONE /

# SCHEDA TECNICA / TECHNICAL DATA

RUBINETTERIE RITMONIO S.R.L. si riserva tutti i diritti connessi con il presente documento e con l'oggetto o la materia ivi rappresentati con divieto di riprodurlo, utilizzarlo o renderlo accessibile a terzi in assenza di previa autorizzazione. Disegno CAD non modificabile a mano

RUBINETTERIE RITMONIO S.R.L. will claim all rights related to the present document and with the object or subject represented therein with the prohibition of reproduction, use or disclosure to third parties without previous permission. The Cad plan is not alterable by hand

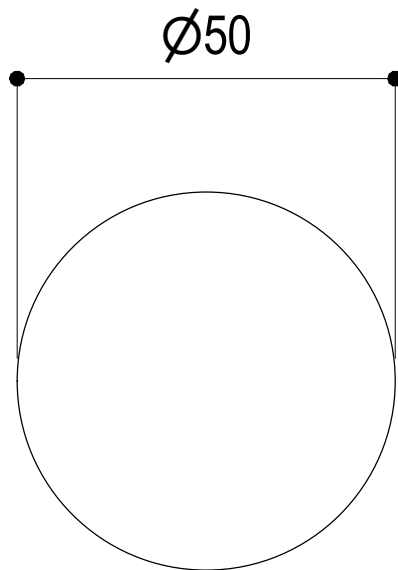
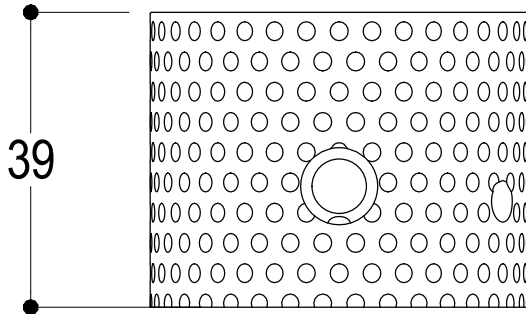

Vista ISO

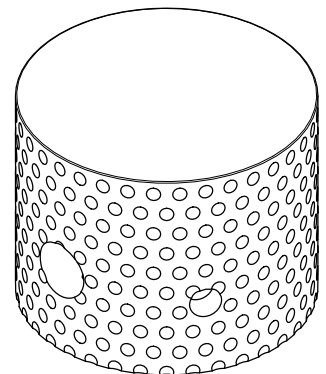

**Ritmonio**  
Living a quality experience.  
13019 VARALLO - (VC) - ITALY

SERIE  
DIAMETRO35 IMPRONTE

CODICE  
PR51MF004

DATA EMISSIONE  
13/01/2022

DENOMINAZIONE  
COMANDO SENZA LEVA  
HANDLE WITHOUT LEVER

REVISIONE /

# SCHEDA DI PORTATA / FLOW RATE DATA

RUBINETTERIE RITMONIO S.R.L. si riserva tutti i diritti connessi con il presente documento e con l'oggetto o la materia ivi rappresentati con divieto di riprodurlo, utilizzarlo o renderlo accessibile a terzi in assenza di previa autorizzazione. Disegno CAD non modificabile a mano

RUBINETTERIE RITMONIO S.R.L. will claim all rights related to the present document and with the object or subject represented therein with the prohibition of reproduction, use or disclosure to third parties without previous permission. The Cad plan is not alterable by hand



Living a quality experience.

13019 VARALLO - (VC) - ITALY

*I diagrammi riportati di seguito riassumono i valori riscontrati durante le prove di portata dei seguenti articoli. Le prove sono state effettuate con pressioni che variavano da 1 a 5 bar e in posizione di acqua miscelata*

*The following diagrams sum up the values, taken from flow tests of the following items. Tests were conducted with pressure variations from 1 to 5 bar and with mixed water.*

## BUILT-IN PARTS

**Art. PM0030H - PM0030J - PM0030L - PM0030M**

*Parte incasso miscelatore termostatico*

*Built-in thermostatic mixer*

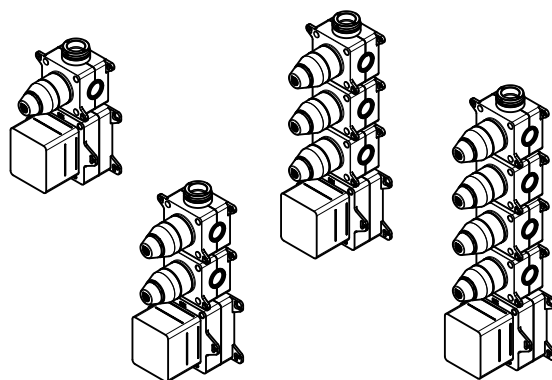

**Una Uscita / One Outlet**

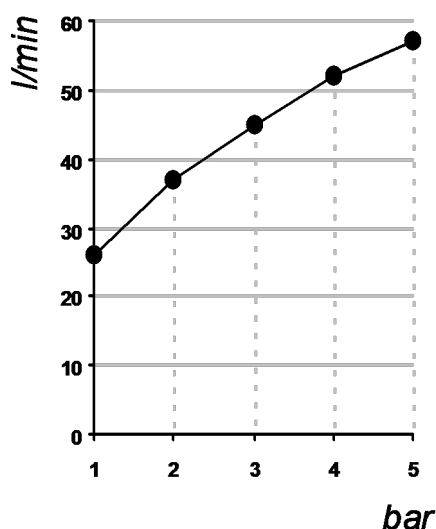

bar	1	2	3	4	5
l/min	26	37	45	52	57

**Due-Tre-Quattro Uscite / Two-Three-Four Outlets**

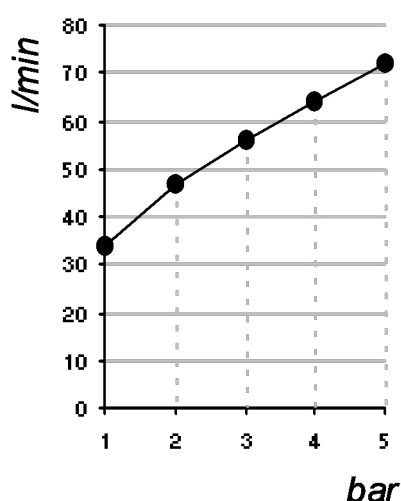

bar	1	2	3	4	5
l/min	34	47	56	64	72

REVISIONE

/

DATA EMISSIONE

29/09/2022