

SCHEDA DI PORTATA / FLOW RATE DATA

RUBINETTERIE RITMONIO S.R.L. si riserva tutti i diritti connessi con il presente documento e con l'oggetto o la materia ivi rappresentati con divieto di riprodurlo, utilizzarlo o renderlo accessibile a terzi in assenza di previa autorizzazione. Disegno CAD non modificabile a mano

RUBINETTERIE RITMONIO S.R.L. will claim all rights related to the present document and with the object or subject represented therein with the prohibition of reproduction, use or disclosure to third parties without previous permission. The Cad plan is not alterable by hand



Living a quality experience.

13019 VARALLO - (VC) - ITALY

I diagrammi riportati di seguito riassumono i valori riscontrati durante le prove di portata dei seguenti articoli. Le prove sono state effettuate con pressioni che variavano da 1 a 5 bar e in posizione di acqua miscelata

The following diagrams sum up the values, taken from flow tests of the following items. Tests were conducted with pressure variations from 1 to 5 bar and with mixed water.

DOT316 ROUND

Art. PR50EG201

Gruppo per bordo vasca
Deck mounted bath group

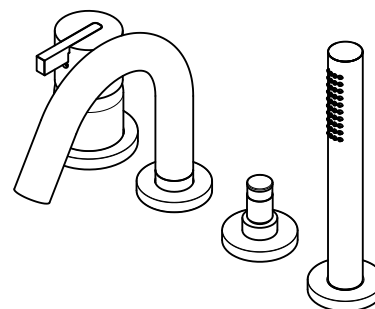

Bocca erogazione / Spout

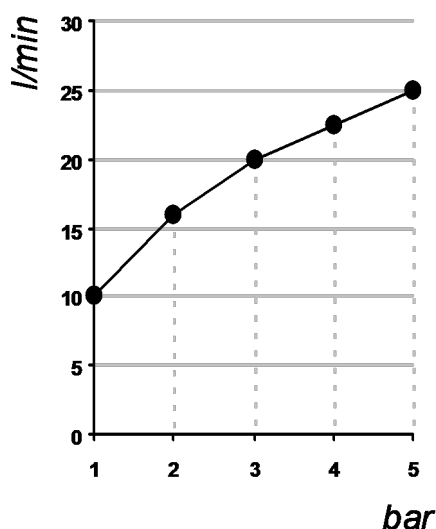

bar	1	2	3	4	5
l/min	10	16	20	22.5	25

Doccetta / Hand shower

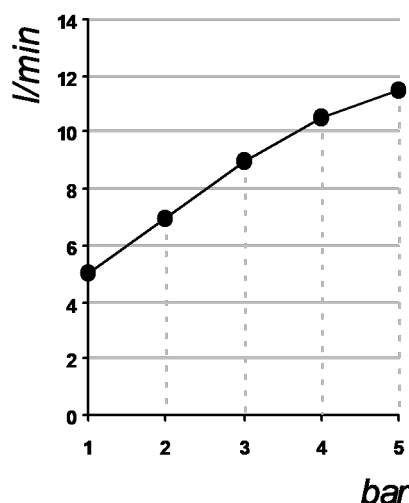

bar	1	2	3	4	5
l/min	5	7	9	10.5	11.5

REVISIONE

rev_1

DATA EMISSIONE

23/06/2022