

SCHEDA TECNICA / TECHNICAL DATA

RUBINETTERIE RITMONIO S.R.L. si riserva tutti i diritti connessi con il presente documento e con l'oggetto o la materia ivi rappresentati con divieto di riprodurlo, utilizzarlo o renderlo accessibile a terzi in assenza di previa autorizzazione. Disegno CAD non modificabile a mano

RUBINETTERIE RITMONIO S.R.L. will claim all rights related to the present document and with the object or subject represented therein with the prohibition of reproduction, use or disclosure to third parties without previous permission. The Cad plan is not alterable by hand

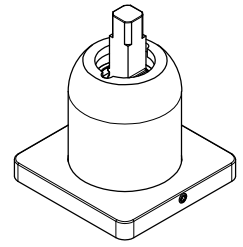

Vista ISO

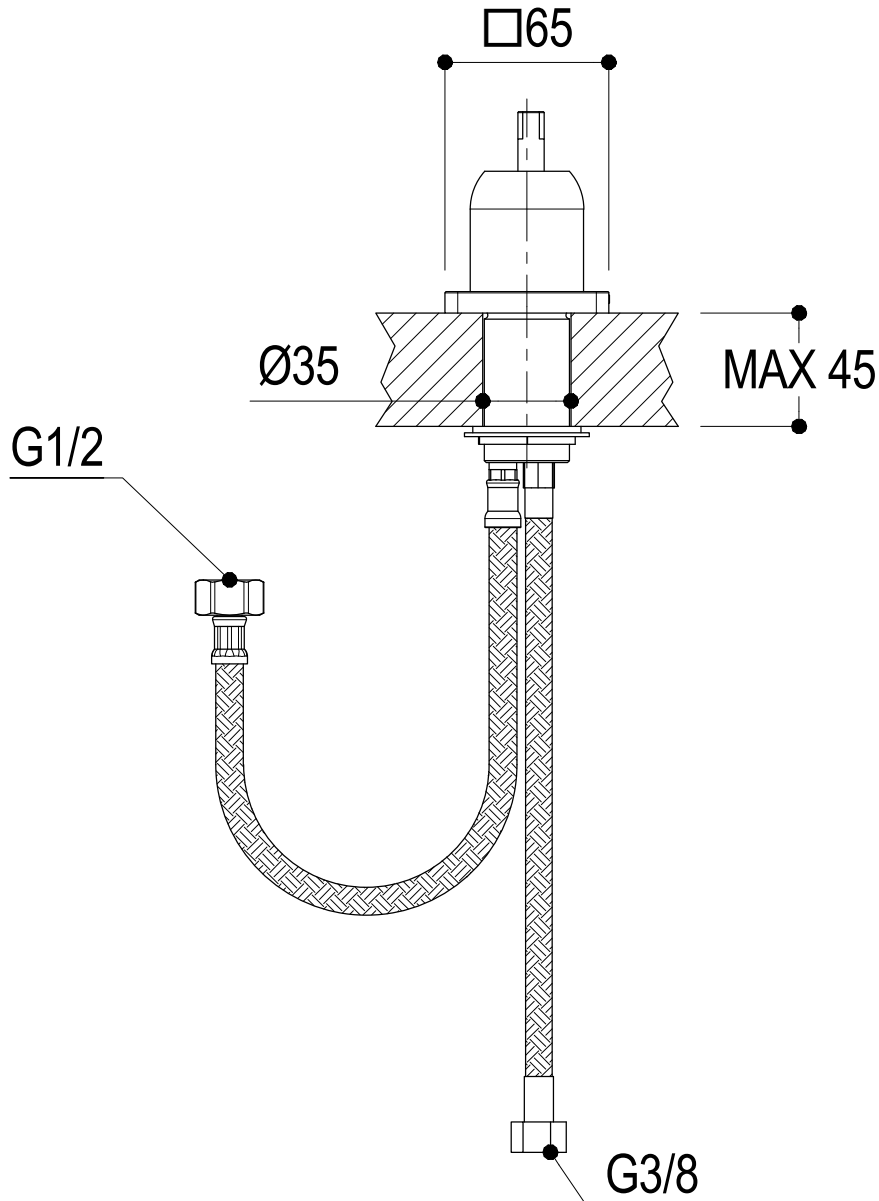

Ritmonio
Living a quality experience.
13019 VARALLO - (VC) - ITALY

| | | | | | |
|---------------|---|--------|-----------|----------------|------------|
| SERIE | HAPTIC | CODICE | PR43AS201 | DATA EMISSIONE | 04/04/2016 |
| DENOMINAZIONE | Miscelatore monocomando Single lever basin mixer | | | | |
| REVISIONE | — | EMESSO | Biglia | APPROVATO | Giusto |

SCHEDA TECNICA / TECHNICAL DATA

RUBINETTERIE RITMONIO S.R.L. si riserva tutti i diritti connessi con il presente documento e con l'oggetto o la materia ivi rappresentati con divieto di riprodurlo, utilizzarlo o renderlo accessibile a terzi in assenza di previa autorizzazione. Disegno CAD non modificabile a mano

RUBINETTERIE RITMONIO S.R.L. will claim all rights related to the present document and with the object or subject represented therein with the prohibition of reproduction, use or disclosure to third parties without previous permission. The Cad plan is not alterable by hand

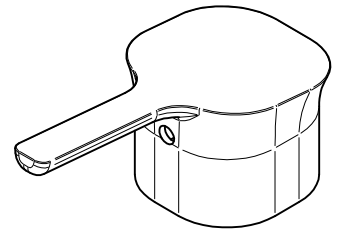

Vista ISO

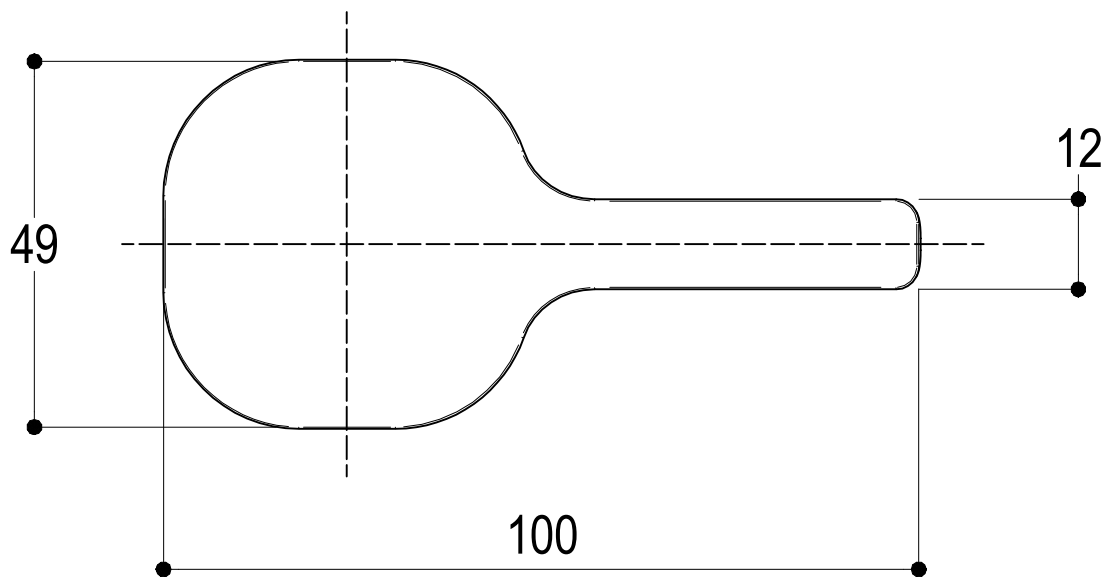
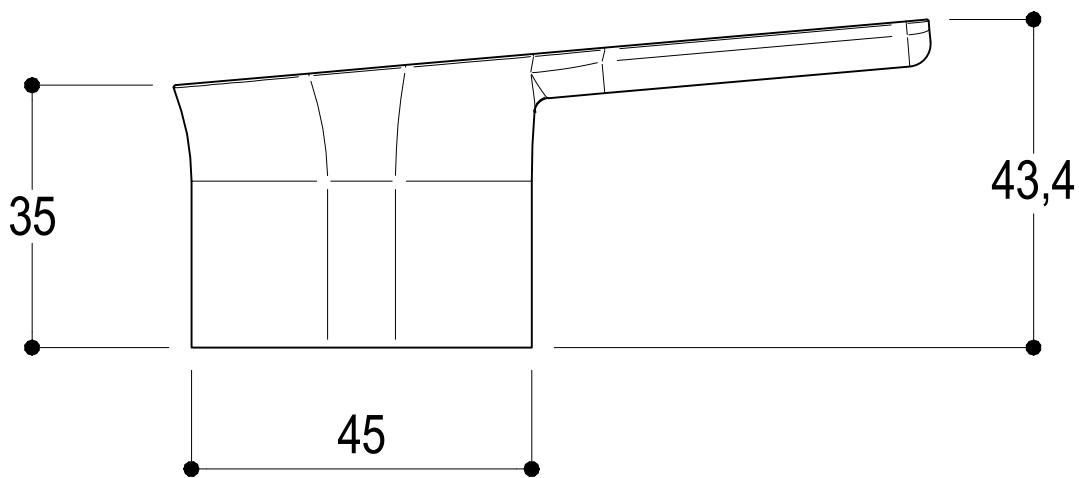

Ritmonio
Living a quality experience.
13019 VARALLO - (VC) - ITALY

SERIE TAORMINA

CODICE PR35MC 101

DATA EMISSIONE 22/06/18

DENOMINAZIONE Comando con leva
Handle with lever

REVISIONE _____

SCHEDA DI PORTATA / FLOW RATE DATA

RUBINETTERIE RITMONIO S.R.L. si riserva tutti i diritti connessi con il presente documento e con l'oggetto o la materia ivi rappresentati con divieto di riprodurlo, utilizzarlo o renderlo accessibile a terzi in assenza di previa autorizzazione. Disegno CAD non modificabile a mano

RUBINETTERIE RITMONIO S.R.L. will claim all rights related to the present document and with the object or subject represented therein with the prohibition of reproduction, use or disclosure to third parties without previous permission. The Cad plan is not alterable by hand



Living a quality experience.

13019 VARALLO - (VC) - ITALY

I diagrammi riportati di seguito riassumono i valori riscontrati durante le prove di portata dei seguenti articoli. Le prove sono state effettuate con pressioni che variavano da 1 a 5 bar e in posizione di acqua miscelata

The following diagrams sum up the values, taken from flow tests of the following items. Tests were conducted with pressure variations from 1 to 5 bar and with mixed water.

HAPTIC

Art. PR43AS201

Miscelatore monocomando per lavabo

Single lever basin mixer

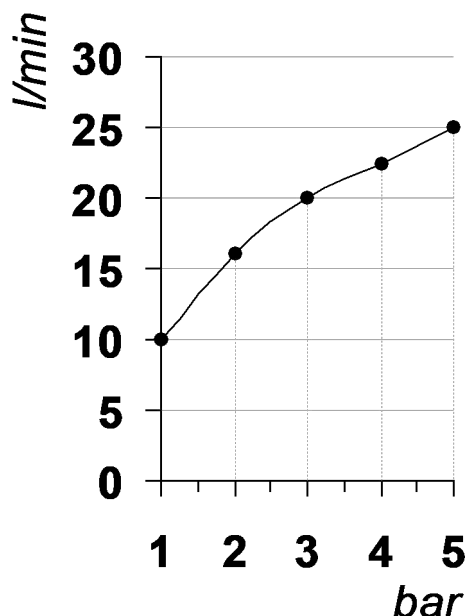

| bar | 1 | 2 | 3 | 4 | 5 |
|-------|----|----|----|------|----|
| l/min | 10 | 16 | 20 | 22.5 | 25 |

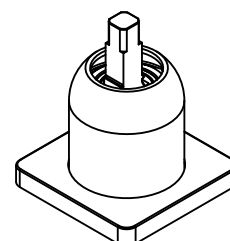

REVISIONE

/

DATA EMISSIONE

24/10/2022