

SCHEDA TECNICA / TECHNICAL DATA

RUBINETTERIE RITMONIO S.R.L. si riserva tutti i diritti connessi con il presente documento e con l'oggetto o la materia ivi rappresentati con divieto di riprodurlo, utilizzarlo o renderlo accessibile a terzi in assenza di previa autorizzazione. Disegno CAD non modificabile a mano

RUBINETTERIE RITMONIO S.R.L. will claim all rights related to the present document and with the object or subject represented therein with the prohibition of reproduction, use or disclosure to third parties without previous permission. The Cad plan is not alterable by hand

DA SOFFITTO

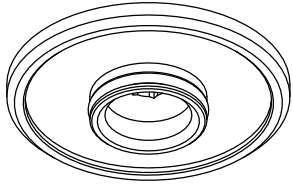

Vista ISO

DA PARETE

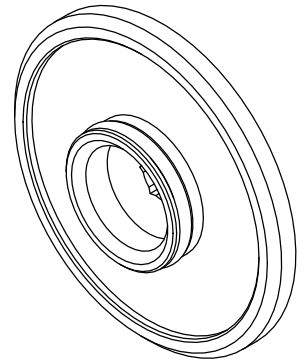

Vista ISO

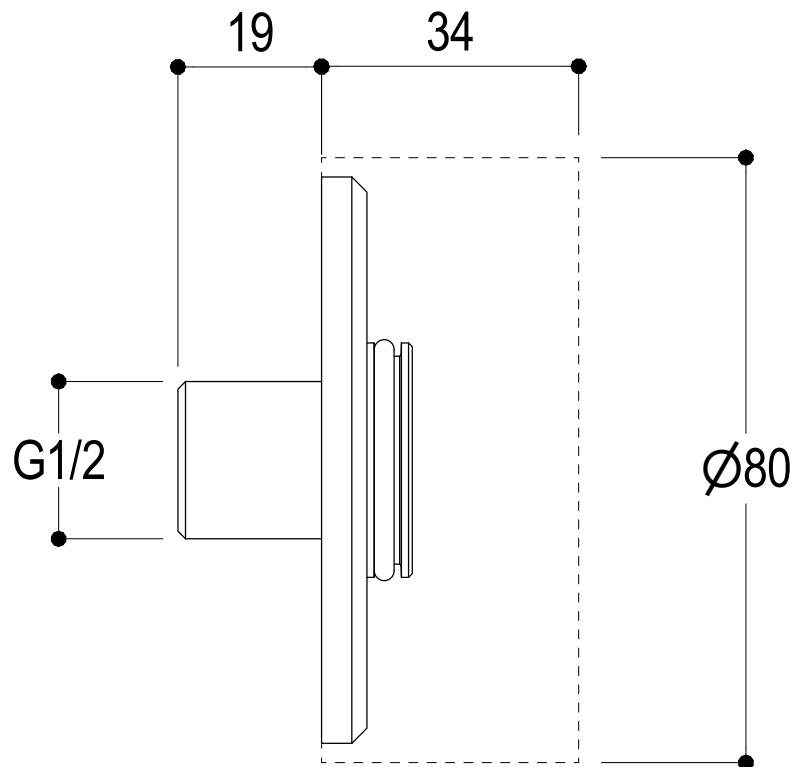

Ritmonio
Living a quality experience.
13019 VARALLO - (VC) - ITALY

SERIE
Ø35 WELLNESS IMPRONTE

CODICE
PR5575AB11

DATA EMISSIONE
10/06/2022

DENOMINAZIONE

Soffione doccia in ottone
Brass shower head

REVISIONE
/

SCHEDA TECNICA / TECHNICAL DATA

RUBINETTERIE RITMONIO S.R.L. si riserva tutti i diritti connessi con il presente documento e con l'oggetto o la materia ivi rappresentati con divieto di riprodurlo, utilizzarlo o renderlo accessibile a terzi in assenza di previa autorizzazione. Disegno CAD non modificabile a mano

RUBINETTERIE RITMONIO S.R.L. will claim all rights related to the present document and with the object or subject represented therein with the prohibition of reproduction, use or disclosure to third parties without previous permission. The Cad plan is not alterable by hand

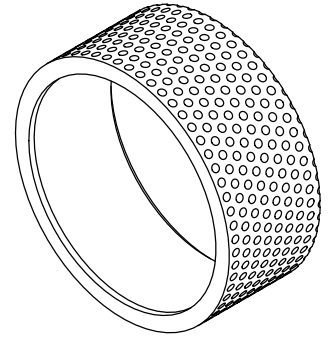

Vista ISO

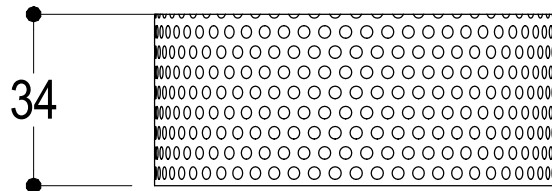
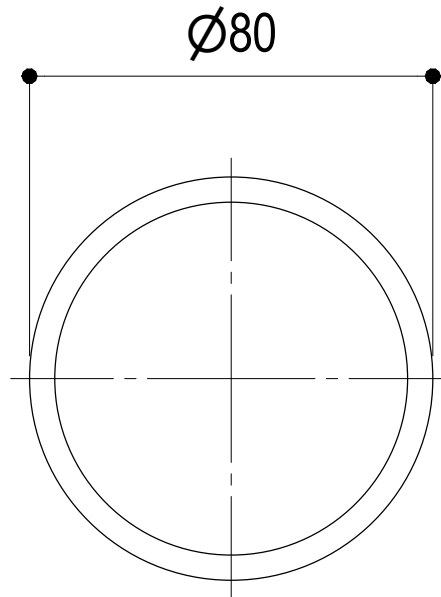

Ritmonio
Living a quality experience.
13019 VARALLO - (VC) - ITALY

SERIE
Ø35 WELLNESS IMPRONTE

CODICE
PR55PA004

DATA EMISSIONE
14/06/2022

DENOMINAZIONE
Ghiera PUNTO
PUNTO ring nut

REVISIONE
/

SCHEDA TECNICA / TECHNICAL DATA

RUBINETTERIE RITMONIO S.R.L. si riserva tutti i diritti connessi con il presente documento e con l'oggetto o la materia ivi rappresentati con divieto di riprodurlo, utilizzarlo o renderlo accessibile a terzi in assenza di previa autorizzazione. Disegno CAD non modificabile a mano

RUBINETTERIE RITMONIO S.R.L. will claim all rights related to the present document and with the object or subject represented therein with the prohibition of reproduction, use or disclosure to third parties without previous permission. The Cad plan is not alterable by hand

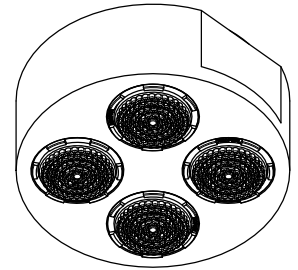

Vista ISO

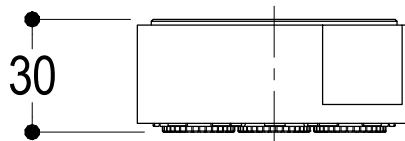
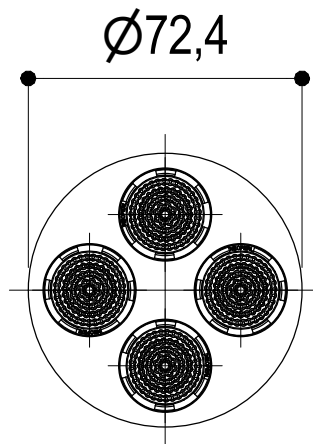

Ritmonio
Living a quality experience.
13019 VARALLO - (VC) - ITALY

SERIE
Ø35 WELLNESS IMPRONTE

CODICE
PR55PB 101

DATA EMISSIONE
13/06/2022

DENOMINAZIONE
Getto Spray
Rain jet

REVISIONE /

SCHEDA DI PORTATA / FLOW RATE DATA

RUBINETTERIE RITMONIO S.R.L. si riserva tutti i diritti connessi con il presente documento e con l'oggetto o la materia ivi rappresentati con divieto di riprodurlo, utilizzarlo o renderlo accessibile a terzi in assenza di previa autorizzazione. Disegno CAD non modificabile a mano

RUBINETTERIE RITMONIO S.R.L. will claim all rights related to the present document and with the object or subject represented therein with the prohibition of reproduction, use or disclosure to third parties without previous permission. The Cad plan is not alterable by hand



Living a quality experience.

13019 VARALLO - (VC) - ITALY

I diagrammi riportati di seguito riassumono i valori riscontrati durante le prove di portata dei seguenti articoli. Le prove sono state effettuate con pressioni che variavano da 1 a 5 bar e in posizione di acqua miscelata

The following diagrams sum up the values, taken from flow tests of the following items. Tests were conducted with pressure variations from 1 to 5 bar and with mixed water.

DIAMETRO35 WELLNESS

Art. PR55PB101

Getto Spray

Rain Jet

Portata con aeratore
Flow rate with aerator

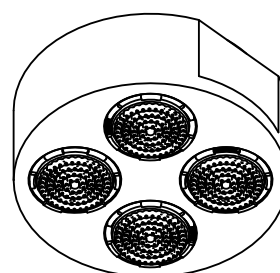
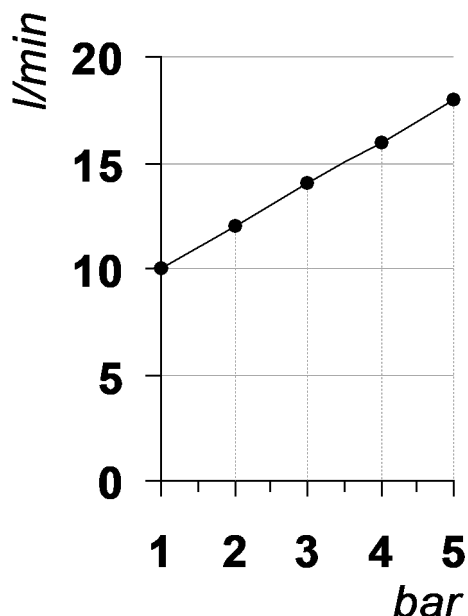

bar	1	2	3	4	5
l/min	10	12	14	16	18

REVISIONE

/

DATA EMISSIONE

12/07/2022