

SCHEDA TECNICA / TECHNICAL DATA

RUBINETTERIE RITMONIO S.R.L. si riserva tutti i diritti connessi con il presente documento e con l'oggetto o la materia ivi rappresentati con divieto di riprodurlo, utilizzarlo o renderlo accessibile a terzi in assenza di previa autorizzazione. Disegno CAD non modificabile a mano

RUBINETTERIE RITMONIO S.R.L. will claim all rights related to the present document and with the object or subject represented therein with the prohibition of reproduction, use or disclosure to third parties without previous permission. The Cad plan is not alterable by hand

Vista ISO

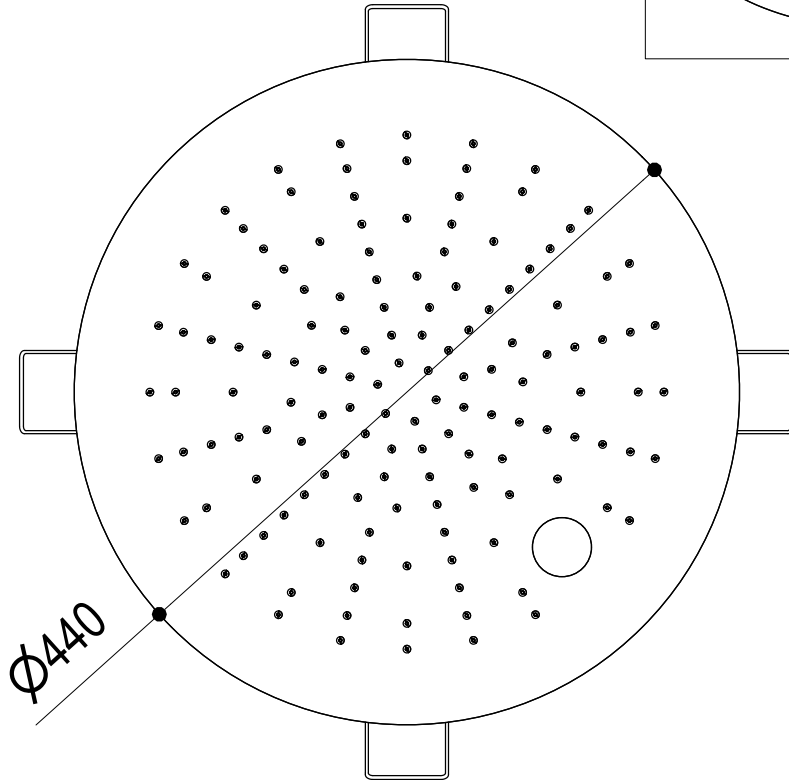
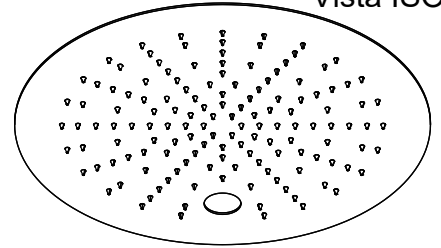

INGOMBRO PER IL CORRETTO FUNZIONAMENTO
ENCUMBRANCE FOR THE CORRECT USE

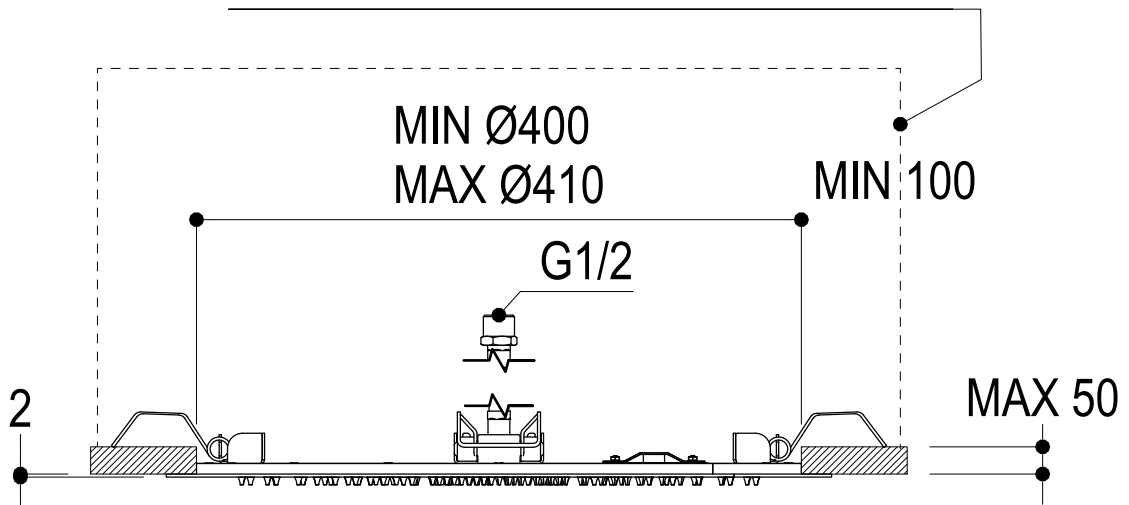

Ritmonio
Living a quality experience.
13019 VARALLO - (VC) - ITALY

SERIE SOFFIONI

CODICE 75IP10

DATA EMISSIONE 18/03/2025

DENOMINAZIONE Soffione ad incasso con cromoterapia
Built-in shower head with chromotherapy

REVISIONE /
/