

# SCHEDA TECNICA / TECHNICAL DATA

RUBINETTERIE RITMONIO S.R.L. si riserva tutti i diritti connessi con il presente documento e con l'oggetto o la materia ivi rappresentati con divieto di riprodurlo, utilizzarlo o renderlo accessibile a terzi in assenza di previa autorizzazione. Disegno CAD non modificabile a mano

RUBINETTERIE RITMONIO S.R.L. will claim all rights related to the present document and with the object or subject represented therein with the prohibition of reproduction, use or disclosure to third parties without previous permission. The Cad plan is not alterable by hand

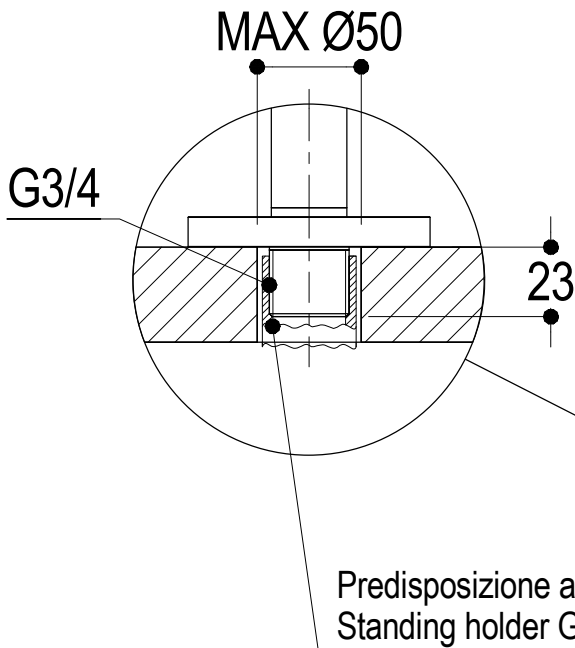
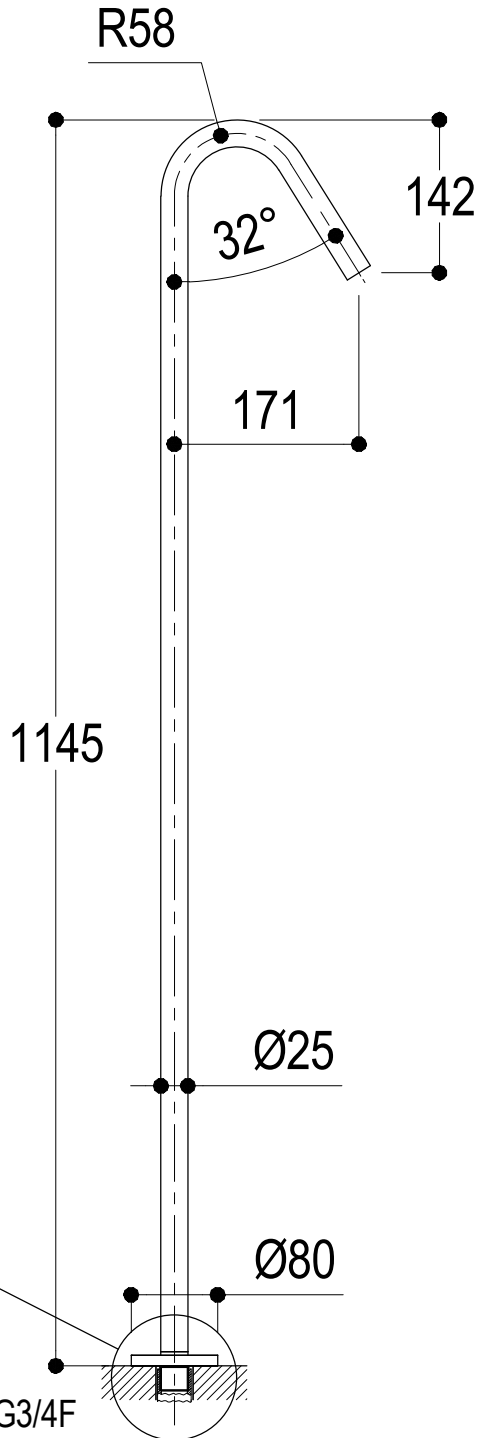
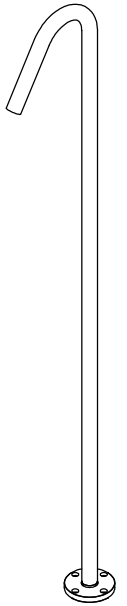
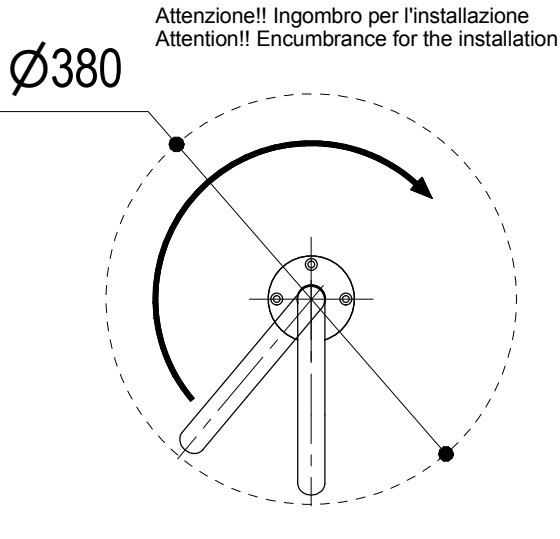

**Ritmonio**  
Living a quality experience.  
13019 VARALLO - (VC) - ITALY

SERIE	Ø35 inox	CODICE	E0BA0104H3	DATA EMISSIONE	18/05/15
DENOMINAZIONE	Bocca di erogazione da terra Standing floor spout				
REVISIONE	/	EMESSO	SIGNORINI	APPROVATO	GIUSTO

# SCHEDA DI PORTATA / FLOW RATE DATA

RUBINETTERIE RITMONIO S.R.L. si riserva tutti i diritti connessi con il presente documento e con l'oggetto o la materia ivi rappresentati con divieto di riprodurlo, utilizzarlo o renderlo accessibile a terzi in assenza di previa autorizzazione. Disegno CAD non modificabile a mano

RUBINETTERIE RITMONIO S.R.L. will claim all rights related to the present document and with the object or subject represented therein with the prohibition of reproduction, use or disclosure to third parties without previous permission. The Cad plan is not alterable by hand



Living a quality experience.

13019 VARALLO - (VC) - ITALY

*I diagrammi riportati di seguito riassumono i valori riscontrati durante le prove di portata dei seguenti articoli. Le prove sono state effettuate con pressioni che variavano da 1 a 5 bar e in posizione di acqua miscelata*

*The following diagrams sum up the values, taken from flow tests of the following items. Tests were conducted with pressure variations from 1 to 5 bar and with mixed water.*

## Ø35 INOX

### Art. E0BA0104H1-H2-H3

*Bocca di erogazione da terra per lavabo*

*Washbasin standing floor spout*

Portata con aeratore  
*Flow rate with aerator*

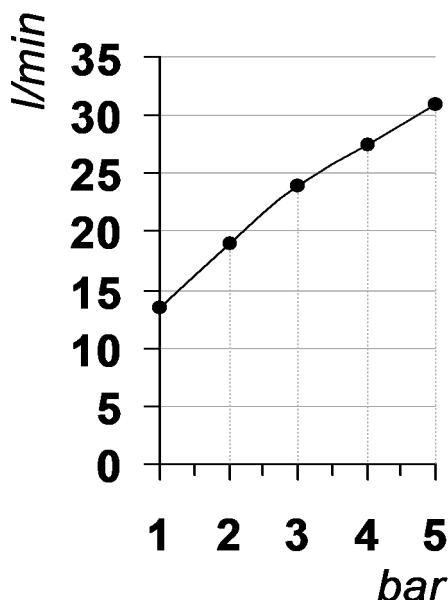

bar	1	2	3	4	5
l/min	13.5	19	24	27.5	31

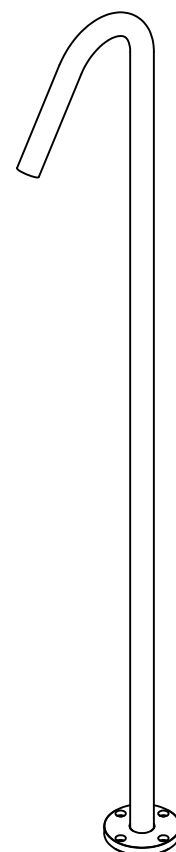

REVISIONE

/

DATA EMISSIONE

31/05/2022